

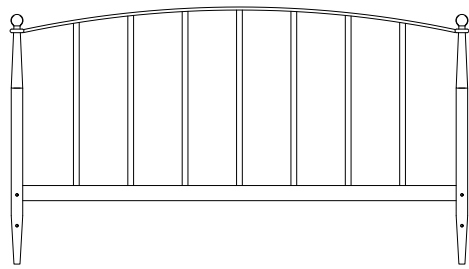

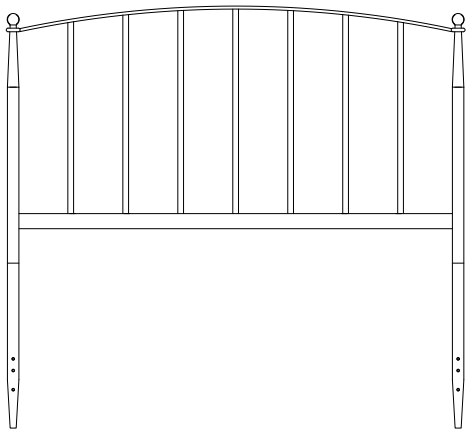

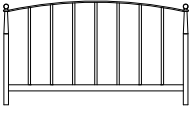

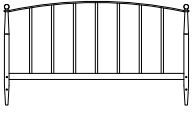
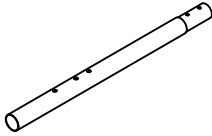

Queen Metal Bedset  
CF91002-503

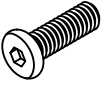
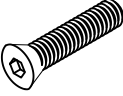

# PART LIST

<p><b>A</b></p> 	<p><b>B</b></p> 	<p><b>C</b></p> 
<p>Headboard Panel 1 PC</p>	<p>Footboard Panel 1 PC</p>	<p>Leg Extension 2 PCS</p>

# HARDWARE LIST

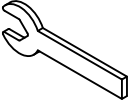
<p><b>#1</b></p>  <p>1/4" x 1/2"L</p>	<p><b>#2</b></p>  <p>1/4" x 3/4"L</p>	<p><b>#3</b></p>  <p>1/4" x 2-1/4"L</p>	<p><b>#4</b></p>  <p>1/4"</p>	<p><b>#5</b></p>  <p>Ø16xØ6.5x1MM</p>
<p>Bolt 4 PCS (Extra 1)</p>	<p>Medium Bolt 4 PCS (Extra 1)</p>	<p>Long Bolt 4 PCS (Extra 1)</p>	<p>Hex Nut 4 PCS (Extra 1)</p>	<p>Flat Washer 12 PCS (Extra 1)</p>
<p><b>#6</b></p> 	<p><b>#7</b></p> 			
<p>Allen Wrench 1 PC</p>	<p>Wrench 1 PC</p>			

Step 1. Lay headboard panel (part A) upside down on a soft flat surface, such as carpet, as shown below. Attach leg extensions (part C) to headboard panel (part A) using bolts (part #1), flat washers (part #5) and allen wrench (part #6).

NOTE: Please do not fully tighten bolts until unit is fully assembled.

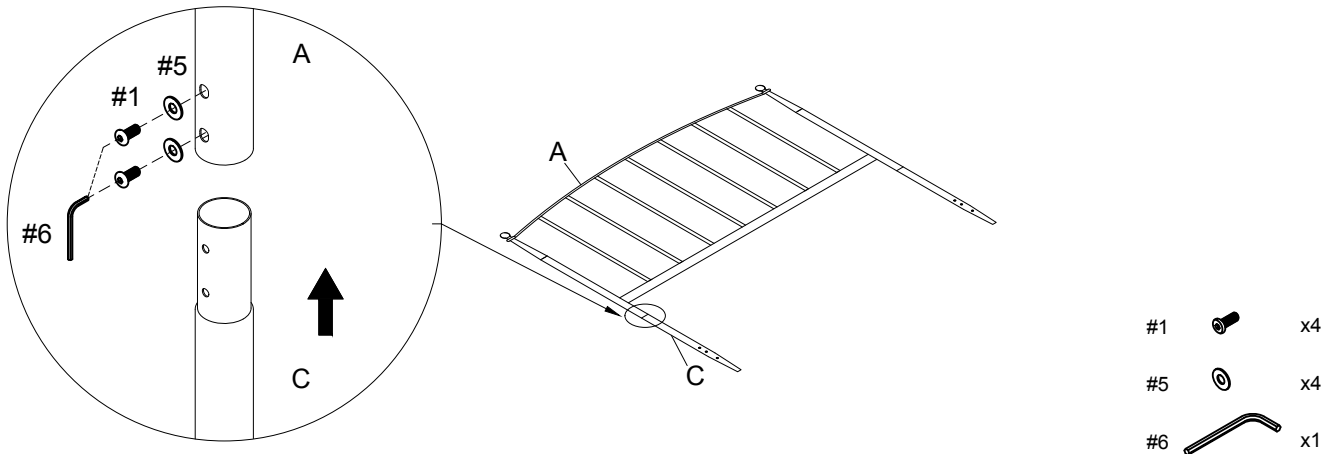

Step 2. Attach bed frame (\*Not Included) to leg extensions (part C) using long bolts (part #3), flat washers (part #5), hex nuts (part #4), allen wrench (part #6) and wrench (part #7).

NOTE: Please do not fully tighten bolts until unit is fully assembled.

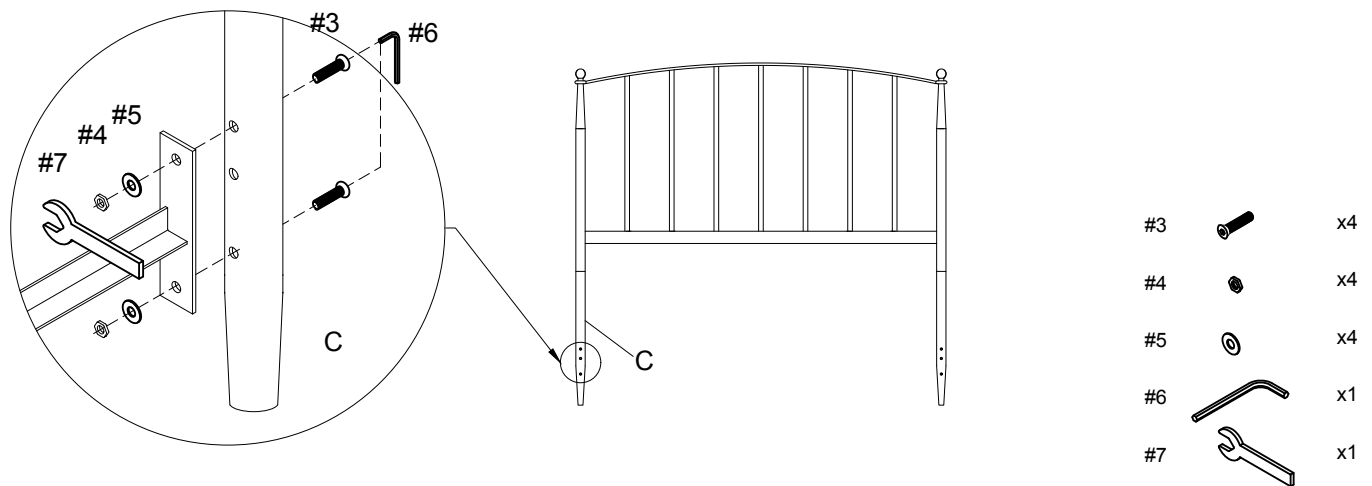

Step 3. Attach bed frame (\*Not Included) to footboard panel (part B) using medium bolts (part #2), flat washers (part #5) and allen wrench (part #6).

NOTE: Please fully tighten all bolts at this time.

